



**falmec**  
Life inspired.

**PRODUCT GUIDE 2023**

UPDATED JULY 2023



## WALL

Afrodite .....	7
Line Pro NRS™ .....	7
Lumen .....	7
Lumen NRS™ .....	8
Lumina NRS™ .....	8
Mercurio.....	8
Mercurio XL.....	9
Mira .....	9
Plane NRS™ .....	9
Plane Top .....	10
Plane Black.....	10
Polar .....	10
Prisma .....	11
Pyramid Pro .....	11
Pyramid Pro NRS™ .....	11
Verso NRS™ .....	12
Vulcano.....	12
Vulcano XL .....	12
Zeus Pro .....	13
Zeus Pro NRS™ .....	13

## UNDERCABINET

Eros.....	13
-----------	----

## CEILING

Alba.....	14
Nube .....	14
Nuvola 140.....	14
Nuvola 90.....	15
Stella .....	15

## ISLAND

Dama .....	16
Elle .....	16
Lumen NRS™ .....	16
Lumen .....	17

## ISLAND

Lumen Isola 175.....	17
Lumina NRS™ .....	17
Mercurio.....	18
Mira .....	18
Plane NRS™ .....	18
Plane Top .....	19
Polar .....	19
Pyramid Pro .....	19
Spazio .....	20

## DOWN DRAFTS

Down Draft .....	20
------------------	----

## BUILT-IN

Danilo .....	21
Gruppo Incasso NRS™.....	21
Mara .....	21
Massimo Pro.....	22
Massimo Pro NRS™ .....	22
Mercurio Built-in .....	22
Move.....	23
Sabina.....	23
Valentina .....	23
Virgola .....	24
Vittorio Pro.....	24

## OUTDOOR

Line Outdoor .....	25
Pyramid Outdoor .....	25
Zeus Outdoor .....	25

Filtration.....	26
Filtering Innovation.....	27
Filter Charts .....	30
Warranty .....	31

# Why Falmecc.

## **Falmecc style: Perfect balance between aesthetic and function.**

Thanks to research and collaboration with leading designers, Falmecc gives life to a variety of products designed to meet every taste and desire with elegance, attention to details and ergonomics, without compromising functionality.

## **The real "Made in Italy" since 1981.**

Each Falmecc product is designed, developed and made entirely in Vittorio Veneto, Italy (near Venice). From the initial concept, to the choice of materials, up to the final product, a constant search for perfection in every production stage is at work that today leads Falmecc to be the qualitative reference in the world of extractor hoods.



## **Life inspired: Technologies & Innovations.**

# Carbon.Zeo

**Filtering innovation.** Charcoal and Zeolite: filtering the way nature intended it to be. A Falmec exclusive, it uses materials of natural origin such as zeolite and activated charcoal to absorb odours with utmost effectiveness. It can last up to 3 years with normal use, and can be regenerated every 18 months.

## **Silence, the importance of acoustic comfort.**

The Noise Reduction System (NRS™) is the technology developed by Falmec that enabled them to create extremely quiet hoods. The NRS™ hoods reduce noise by up to 86% in sound level while giving the best results in removal of cooking fumes.



## **Speed reduction system - SRS.**

The SRS system reduces the maximum air flow rate that can be set in the hood to make the hood compliant to local building regulations.



# Circle.Tech: The New Shape of Filtration



## Circle.Tech, a certified and patented technology.

Unlike traditional cooker hoods, Circle.Tech filtering units extract air horizontally rather than vertically. The outflowing air passes through a filtering unit (powered by Carbon.Zeo technology) surrounding the motor and is evenly distributed. Given its circular shape, the filtering surface reaches the maximum extension, thus achieving excellent performances in terms of suction capacity, top filtering results and extreme quietness.

Indeed, balanced distribution of outflowing air reduces turbulence and, consequently, the noise produced by the hood.

## A unique innovation in several different shapes.

Circle.Tech is available  
in these fine hoods:

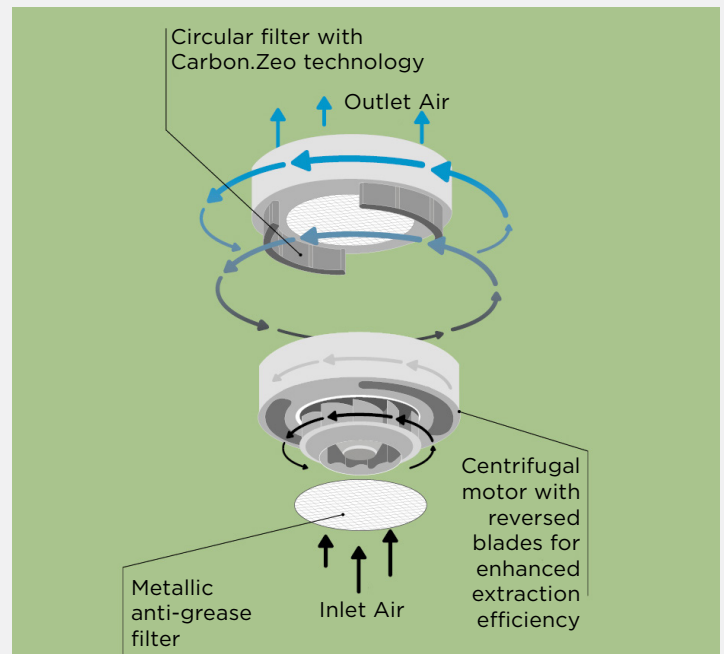

Scan this QR Code  
to see how  
Circle.Tech works:



**WALL HOODS**



**AFRODITE**

MODEL	CODE	WIDTH	CFM
AFRODITE	FPAFX30W6SS	30"	600
AFRODITE	FPAFX36W6SS	36"	600

**FEATURES**

- ScotchBrite stainless steel AISI 304
- 3-speed slider controls
- LED lighting: 2 X 1,2W
- Metallic filters, removable and washable
- Optional round charcoal filter, Type 6 (FFCHAR3C0BL)



**LINE PRO NRS™**

MODEL	CODE	WIDTH	CFM
LINE PRO NRS™	FNLIN30W6SS	30"	600
LINE PRO NRS™	FNLIN36W6SS	36"	600

**FEATURES**

- ScotchBrite stainless steel AISI 304
- NRS™ technology for a quieter kitchen
- 4-speed touch controls + 24h function
- LED strip lighting
- Auto delay shut-off function
- Clean filter reminder Professional baffle filters
- Optional Carbon.Zeo filter kit (KACL.948#IF)
- Optional Carbon.Zeo filter kit, vertical outlet ceiling (KACL.953#BF)
- Optional Carbon.Zeo Filter (KACL.961)
- Optional duct extension H=70cm (KACL.570#I) / H=96cm (KACL.571#I)



**LUMEN**

MODEL	CODE	WIDTH	CFM
LUMEN	FDLUM36W5SS-R	36"	500

**FEATURES**

- Speed Reduction System (SRS)
- ScotchBrite stainless steel AISI 304
- 4-speed electronic controls
- LED strip lighting
- LED ambient light
- Auto delay shut-off function
- Air Falmec filter for balanced suction, removable and washable
- Optional Carbon.Zeo filter kit (KACL.948#IF)
- Optional square charcoal filter, Type 3 (FFCHASQC0BL)
- Optional duct extension H=70cm (KACL.510#I) / H=96cm (KACL.512#I)

Specifications and features may vary. Please refer to the manufacturer's website for the latest updates.

**WALL HOODS**



**LUMEN NRS™**

MODEL	CODE	WIDTH	CFM
LUMEN NRS™	FNLUM36W5SS-R	36"	500

**FEATURES**

- NRS™ technology for a quieter kitchen
- Speed Reduction System (SRS)
- ScotchBrite stainless steel AISI 304
- 4-speed electronic controls
- Auto delay shut-off function
- Clean filter reminder
- LED strip lighting: 4000K
- LED ambient light
- Air Falmec filters, removable and washable
- Optional Carbon.Zeo Filter kit (KACL.961)



**LUMINA NRS™**

MODEL	CODE	WIDTH	CFM
LUMINA NRS™	FNLUM36W5SS	36"	500

**FEATURES**

- ScotchBrite stainless steel AISI 304 + Tempered glass with steel look finish
- NRS™ technology for a quieter kitchen
- 4-speed touch controls + 24 hour function
- Auto delay shut-off function
- Clean filter reminder
- Fluorescent lighting
- White fluorescent ambient light
- Metallic filters, removable and washable
- Perimeter suction
- Optional Carbon.Zeo filter kit (KACL.961)
- Optional duct extension H=70cm (KACL.570#1) / H=96cm (KACL.571#1)



**MERCURIO**

MODEL	CODE	WIDTH	CFM
MERCURIO	FPMER24W3SS	24"	280
MERCURIO	FPMER30W3SS	30"	280
MERCURIO	FPMER36W3SS	36"	280

**FEATURES**

- ScotchBrite stainless steel AISI 430
- 3-speed mechanical controls
- LED lighting: 2 X 1,2W
- Metallic filters, removable and washable
- Optional square charcoal filter, Type 3
- Optional duct extension H=70cm (KACL.510#3) / H=96cm (KACL.512#3)

Specifications and features may vary. Please refer to the manufacturer's website for the latest updates.



**WALL HOODS**



**MERCURIO XL**



**MIRA**



**PLANE NRS™**

MODEL	CODE	WIDTH	CFM
MERCURIO XL	FPMEX30W6SS-R	30"	600
MERCURIO XL	FPMEX36W6SS-R	36"	600

**FEATURES**

- Speed Reduction System (SRS)
- ScotchBrite stainless steel AISI 430
- 4-speed electronic controls
- Auto delay shut-off function
- Clean filter reminder
- LED lighting: 2 X 1,2W
- Metallic filters, removable and washable
- Optional square charcoal filter, Type 3 (FFCHASQC0BL)
- Optional duct extension H=70cm (KACL.510#3) / H=96cm (KACL.512#3)

MODEL	CODE	WIDTH	CFM
MIRA	FDMIR16W5SS-R	16"	500

**FEATURES**

- Speed Reduction System (SRS)
- ScotchBrite stainless steel AISI 304
- Perimeter Suction
- 4-speed electronic controls
- Auto delay shut-off function
- Clean filter reminder
- LED lighting: 2 X 1,2W
- Metallic filters, removable and washable
- Optional square charcoal filter, Type 3 (FFCHASQC0BL)

MODEL	CODE	WIDTH	CFM
PLANE NRS™	FNPLS30W5SS-R	30"	500
PLANE NRS™	FNPLS36W5SS-R	36"	500
PLANE NRS™	FNPLS48W5SS-R	48"	500

**FEATURES**

- Speed Reduction System (SRS)
- ScotchBrite stainless steel AISI 304
- NRS™ technology for a quieter kitchen
- 4-speed electronic controls
- Auto delay shut-off function
- Clean filter reminder
- LED lighting
- AirFalmec filter for balanced suction
- Optional Carbon.Zeo filter kit (KACL.961)
- Optional duct extension H=70cm (KACL.570#1) / H=96cm (KACL.571#1)

Specifications and features may vary. Please refer to the manufacturer's website for the latest updates.

**WALL HOODS**



**PLANE TOP**



**PLANE BLACK**



**POLAR**

MODEL	CODE	WIDTH	CFM
PLANE TOP	FFPLN36W5FS-R	36"	500
PLANE TOP	FFPLN48W5FS-R	48"	500

**FEATURES**

- Speed Reduction System (SRS)
- ScotchBrite Fasteel no finger print
- Perimeter Suction
- 4-speed electronic controls
- Auto delay shut-off function
- Clean filter reminder
- LED lighting: (36") 2 X 1,2W / (48") 3 X 1,2W
- Metallic filters, removable and washable
- Optional square charcoal filters, Type 3 (FFCHASQC0BL)
- Optional Carbon.Zeo filter kit (KACL.948#IF)
- Optional duct extension H=70cm (KACL.510#X) / H=96cm (KACL.512#X)

MODEL	CODE	WIDTH	CFM
PLANE BLACK	FDPLN36W5MB-R	36"	500

**FEATURES**

- Matte black finish
- Speed Reduction System (SRS)
- Perimeter Suction
- 4-speed electronic controls
- LED lighting: 2 X 1,2W
- Charcoal filter included
- Metallic filters, removable and washable
- Optional square charcoal filter, Type 3 (FFCHASQC0BL)
- Optional Carbon.Zeo filter kit (KACL.948#IF)

MODEL	CODE	WIDTH	CFM
POLAR	FDPLR15W5SS-R	15"	500

**FEATURES**

- Speed Reduction System (SRS)
- ScotchBrite stainless steel AISI 304
- 4-speed electronic controls
- Auto delay shut-off function
- Clean filter reminder
- LED lighting: 3 X 1,2W
- Top filter, removable and washable
- Optional round charcoal filter, Type 6 (FFCHAR3C0BL)

Specifications and features may vary. Please refer to the manufacturer's website for the latest updates.

**WALL HOODS**



**PRISMA**

MODEL	CODE	WIDTH	CFM
PRISMA (black)	FDPRI36W5SB	36"	500
PRISMA (white)	FDPRI36W5SW	36"	500

**FEATURES**

- Tempered white or black glass
- ScotchBrite stainless steel AISI 304
- 4-speed touch controls + 24 h function
- Auto delay shut-off function
- Clean filter reminder
- Charcoal filter included
- LED lighting: 2 X 1,2W
- Ambient LED lighting: 2 X 1,2W (3200K)
- Perimeter suction
- Top filter, removable and washable
- Possible to duct wall mounted from rear
- Optional round charcoal filter, Type 6 (FFCHAR3C0BL)
- Optional Carbon.Zeo filter kit, for sloped hoods (KACL.941)
- Optional duct extension, Stainless Steel (KCQAN.00#I)

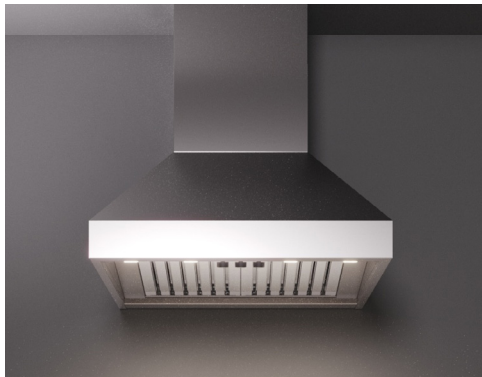

**PYRAMID PRO**

MODEL	CODE	WIDTH	CFM
PYRAMID PRO	FPDPR30W6SS-3	30"	600
PYRAMID PRO	FPDPR36W9SS-3	36"	1000
PYRAMID PRO	FPDPR48W9SS-3	48"	1000

**FEATURES**

- ScotchBrite stainless steel AISI 304
- 4-speed knob control
- LED lighting
- Professional baffle filters
- Removable liquid collector

Transition required to go from 2x6" round duct to 1x8" round duct is included with all dual motor units.



**PYRAMID PRO NRS™**

MODEL	CODE	WIDTH	CFM
PYRAMID PRO NRS™	FNPYR30W6SS	30"	600
PYRAMID PRO NRS™	FNPYR36W6SS	36"	600

**FEATURES**

- ScotchBrite stainless steel AISI 304
- NRS™ technology for a quieter kitchen
- 4-speed touch controls + 24 h function
- LED strip lighting
- Professional baffle filters
- Auto delay shut-off function
- Clean filter reminder
- Optional Carbon.Zeo filter kit, vertical outlet ceiling (KACL.953#BF)
- Optional Carbon.Zeo filter kit (KACL.948#IF)

Specifications and features may vary. Please refer to the manufacturer's website for the latest updates.

**WALL HOODS**



**VERSO NRS™**



**VULCANO**



**VULCANO XL**

MODEL	CODE	WIDTH	CFM
VERSO NRS™ (black)	FDVER36W5BK	36"	500
VERSO NRS™ (white)	FDVER36W5WH	36"	500

**FEATURES**

- NRS™ technology for a quieter kitchen
- Tempered glass, black or white
- 4-speed touch controls + 24h function
- Auto delay shut-off function
- Clean filter reminder
- Chimney included
- Charcoal filter included
- Dynamic LED lights (2700K - 5600K)
- Double suction area (frontal & lower)
- Top filter, removable and washable



MODEL	CODE	WIDTH	CFM
VULCANO	FPVUL24W3SS	24"	280
VULCANO	FPVUL30W3SS	30"	280
VULCANO	FPVUL36W3SS	36"	280

**FEATURES**

- ScotchBrite Stainless Steel AISI 430
- 4-speed mechanical controls
- LED lighting
- Auto delay shut-off function
- Clean filter reminder
- Labyrinth metallic filters, removable and washable
- Optional square charcoal filter, Type 3 (FFCHASQC0BL)
- Optional duct extension, H=70cm (KACL.510#3) / H=96cm (KACL.512#3)

MODEL	CODE	WIDTH	CFM
VULCANO XL	FPVUX30W6SS-R	30"	600
VULCANO XL	FPVUX36W6SS-R	36"	600

**FEATURES**

- Speed Reduction System (SRS)
- ScotchBrite Stainless Steel AISI 430
- 4-speed electronic controls
- LED lighting: 2 X 1,2W
- Auto delay shut-off function
- Clean filter reminder
- Labyrinth metallic filters, removable and washable
- Optional square charcoal filter, Type 3 (FFCHASQC0BL)
- Optional duct extension, H=70cm (KACL.510#3) / H=96cm (KACL.512#3)

Specifications and features may vary. Please refer to the manufacturer's website for the latest updates.

**WALL HOODS**



**ZEUS PRO**

MODEL	CODE	WIDTH	CFM
ZEUS PRO	FP18P30W6SS-3	30"	600
ZEUS PRO	FP18P36W6SS-3	36"	600
ZEUS PRO	FP18P36W9SS-3	36"	1000
ZEUS PRO	FP18P48W9SS-3	48"	1000

**FEATURES**

- ScotchBrite stainless steel AISI 304
- 4-speed knob controls
- LED lighting
- Professional baffle filters
- Optional duct extension  
(30" - KCPHN.004#3F / 36" - KCPHN.005#3F / 48" - KCPHN.006#3F)



**ZEUS PRO NRS™**

MODEL	CODE	WIDTH	CFM
ZEUS PRO NRS™	FNZEU30W6SS	30"	600
ZEUS PRO NRS™	FNZEU36W6SS	36"	600

**FEATURES**

- Scotch brite stainless steel AISI 304
- NRS™ technology for a quieter kitchen
- 4-speed touch control + 24 h function
- Auto delay shut-off function
- Clean filter reminder
- LED lights: 2 x 1,2 W (3200K)
- Professional Baffle Filters
- Removable liquid collector
- Optional Carbon.Zeo kit (KACL.948#1F)
- Optional duct extension, H=70cm (KACL.570#1) / H=96cm (KACL.571#1)

**UNDERCABINET**



**EROS**

MODEL	CODE	WIDTH	CFM
EROS	FPERO30U5SS-R	30"	500
EROS	FRERO36U5SS-R	36"	500

**FEATURES**

- Speed Reduction System (SRS)
- ScotchBrite stainless steel AISI 304
- 4-speed electronic controls
- Auto delay shut-off function
- Clean filter reminder
- LED lighting: 2 X 1,2W (3200K)
- Labyrinth filters
- Optional round charcoal filter, Type 6 (FFCHAR3COBL)

Specifications and features may vary. Please refer to the manufacturer's website for the latest updates.

**CEILING HOODS**



**ALBA**

\* THE COMPATIBLE BLOWER, MODEL FDNUNMTR600, IS NOT INCLUDED IN THE HOOD AND IS THEREFORE SOLD SEPARATELY.



**NUBE**

\* THE COMPATIBLE BLOWER, MODEL FDNUNMTR600, IS NOT INCLUDED IN THE HOOD AND IS THEREFORE SOLD SEPARATELY.



**NUVOLA 140**

\* THE COMPATIBLE BLOWER, MODEL FDNUNMTR600, IS NOT INCLUDED IN THE HOOD AND IS THEREFORE SOLD SEPARATELY.

MODEL	CODE	WIDTH	CFM
ALBA	FDALB48C6WH-R	48"	600*

**FEATURES**

- Speed Reduction System (SRS)
- Matte white painted panel (possibility of painting the panel)
- Glass perimeter frame
- Perimeter suction
- Perimeter LED lighting (4000K)
- 4 speed electronic controls
- Auto delay shut-off function
- Metallic filters, removable and washable
- Remote control included
- Optional Carbon.Zeo filter kit, vertical outlet ceiling (KACL.953#BF)
- Optional Carbon.Zeo filter replacement (KACL.931)
- Maximum distance between ceiling hood and cooktop is 59 inches (150 cm).

MODEL	CODE	WIDTH	CFM
NUBE	FDNUB36C6SS-R	36"	600*

**FEATURES**

- Speed Reduction System (SRS)
- ScotchBrite stainless steel AISI 304
- Perimeter suction
- 4-speed electronic controls
- Auto delay shut-off function
- Metallic filters, removable and washable
- Remote control included
- Optional ceiling recirculation filter pack (KACL.939#BF)
- Optional Carbon.Zeo filter kit, vertical outlet ceiling (KACL.953#BF)
- Optional side junction for ceiling (KACL.789)
- Remote control replacement (105080053)
- Maximum distance between ceiling hood and cooktop is 59 inches (150 cm).

MODEL	CODE	WIDTH	CFM
NUVOLA 140 (stainless)	FDNUV54C6SS-R1	54"	600*
NUVOLA 140 (white)	FDNUV54C6WH-R1	54"	600*

**FEATURES**

- Speed Reduction System (SRS)
- ScotchBrite stainless steel AISI 304 or painted white
- Tempered extra light painted glass
- Perimeter suction
- 4 speed electronic controls
- Auto delay shut-off function
- Dynamic LED lighting (2700K-5600K)
- Metallic filters, removable and washable
- Remote control included
- Optional ceiling recirculation filter pack (KACL.939#BF)
- Optional Carbon.Zeo filter kit, vertical outlet ceiling (KACL.953#BF)
- Optional side junction for ceiling (KACL.789)
- Remote control replacement (105080053)
- Maximum distance between ceiling hood and cooktop is 59 inches (150 cm).

Specifications and features may vary. Please refer to the manufacturer's website for the latest updates.

**CEILING HOODS**



**NUVOLA 90**

\* THE COMPATIBLE BLOWER, MODEL FDNUNMTR600, IS NOT INCLUDED IN THE HOOD AND IS THEREFORE SOLD SEPARATELY.



**STELLA**

\* THE COMPATIBLE BLOWER, MODEL FDNUNMTR600, IS NOT INCLUDED IN THE HOOD AND IS THEREFORE SOLD SEPARATELY.



MODEL	CODE	WIDTH	CFM
NUVOLA 90 (stainless)	FDNUV36C6SS-R1	36"	600*
NUVOLA 90 (white)	FDNUV36C6WH-R1	36"	600*

**FEATURES**

- Speed Reduction System (SRS)
- ScotchBrite stainless steel AISI 304 or painted white
- Tempered extra light painted glass
- Perimeter suction
- 4 speed electronic controls
- Auto delay shut-off function
- Dynamic LED lighting
- Metallic filters, removable and washable
- Remote control included
- Optional ceiling recirculation filter pack (KACL.939#BF)
- Optional Carbon.Zeo filter kit, vertical outlet ceiling (KACL.953#BF)
- Optional side junction for ceiling (KACL.789)
- Remote control replacement (105080053)
- Maximum distance between ceiling hood and cooktop is 59 inches (150 cm).

MODEL	CODE	WIDTH	CFM
STELLA	FDSTE36C6SS-R	36"	600
STELLA	FDSTE48C6SS-R	48"	600

**FEATURES**

- Speed Reduction System (SRS)
- ScotchBrite stainless steel AISI 304
- Perimeter suction
- 4-speed electronic controls
- Auto delay shut-off function
- Dynamic LED lighting (2700K-5600K)
- Metallic filters removable and washable
- Remote control included
- Optional ceiling recirculation filter pack (KACL.939#BF)
- Optional Carbon.Zeo filter kit, vertical outlet ceiling (KACL.953#BF)
- Optional side junction for ceiling (KACL.789)
- Remote control replacement (105080053)
- Maximum distance between ceiling hood and cooktop is 59 inches (150 cm).

ITEM	MODEL
REMOTE UNDER-ROOF MOTOR	FDNUVMTR600

- Under-roof extractor fan 600 CFM
- Kit external motor 23 feet (7 m) wiring.
- Suitable for hoods provided with 600 CFM motor only (if used as remote under-roof unit )

Specifications and features may vary. Please refer to the manufacturer's website for the latest updates.

**ISLAND HOODS**



**NEW! DAMA**

MODEL	CODE	WIDTH	CFM
DAMA	FCDAM24I4RC	24"	360

**FEATURES**

- Circle.Tech technology with Carbon.Zeo filters
- Copper finish
- 4-speed rotary controls
- Auto delay shut-off function
- Clean filter reminder
- LED lighting: 4 x 1,2W (4200K)
- LED ambient light: 14W (4200K)
- Perimeter suction with tempered glass panel
- Metallic grease filter, removable and washable
- Available only in filtering version
- Optional remote control (105080053)



**NEW! ELLE**

MODEL	CODE	WIDTH	CFM
ELLE	FDLL70I5SS	70"	500

**FEATURES**

- Speed Reduction System (SRS)
- Matte black painted steel
- 4-speed electronic controls
- Dynamic LED Lighting (2700K - 5600K)
- Dimmable LED lighting
- Auto delay shut-off function
- Clean filter reminder
- Perimeter suction
- Metallic grease filter, removable and washable
- Optional Carbon.Zeo Filter kit (KACL.961)
- Optional remote control (105080053)



**NEW! LUMEN NRS™**

MODEL	CODE	WIDTH	CFM
LUMEN NRS™	FNLUM36I5SS-R	36"	500

**FEATURES**

- NRS™ technology for a quieter kitchen
- Speed Reduction System (SRS)
- ScotchBrite stainless steel AISI 304
- 4-speed electronic controls
- Auto delay shut-off function
- Clean filter reminder
- LED strip lighting (4000K)
- LED ambient light
- Air Falmec filters, removable and washable
- Optional Carbon.Zeo Filter kit (KACL.961)

Specifications and features may vary. Please refer to the manufacturer's website for the latest updates.



**ISLAND HOODS**



**LUMEN**



**LUMEN ISOLA 175**



**LUMINA NRS™**

MODEL	CODE	WIDTH	CFM
LUMEN	FDLUM36I5SS-R	36"	500

**FEATURES**

- Speed Reduction System (SRS)
- ScotchBrite stainless steel AISI 304
- 4-speed electronic controls
- Auto delay shut-off function
- LED lighting
- LED ambient light
- AirFalmec filter for balanced suction
- Optional square charcoal filter, Type 3 (FFCHASQC0BL)
- Optional Carbon.Zeo filter kit (KACL.949#IF)
- Optional duct extension, H=120cm (KACL.557#I)

MODEL	CODE	WIDTH	CFM
LUMEN ISOLA RIGHT	FDLUM70I5SS-2R	70"	500
LUMEN ISOLA LEFT	FDLUM70I5SS-2L	70"	500

**FEATURES**

- Scotch brite stainless steel AISI 304
- Perimetric suction
- LED lighting strip
- LED ambient lighting on both sides
- 4-speed electronic control on one side only\*
- 4-speed touch controls
- Auto delay shut-off function
- Clean filter reminder
- Metallic grease filter, removable and washable
- Optional Carbon.Zeo filter kit (KACL.949#IF)
- Optional square charcoal filter, Type 3 (FFCHASQC0BL)
- Optional duct extension, H=120cm (KACL.557#I)
- Optional rod extension, H=120cm (KACL.350)

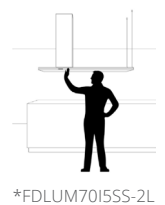

MODEL	CODE	WIDTH	CFM
LUMINA NRS™	FNLUM36I5SS	36"	500

**FEATURES**

- Scotch brite stainless steel AISI 304 + Tempered glass with steel finish
- NRS™ technology for a quieter kitchen
- Perimeter suction
- 4-speed touch controls + 24 h function
- Auto delay shut-off function
- Clean filter reminder
- White fluorescent ambient light
- Fluorescent lighting
- Metallic grease filter, removable and washable
- Optional Carbon.Zeo filter kit (KACL.961)
- Optional duct extension, H=120cm (KACL.572#I)

Specifications and features may vary. Please refer to the manufacturer's website for the latest updates.

**ISLAND HOODS**



**MERCURIO**

MODEL	CODE	WIDTH	CFM
MERCURIO	FPMEX36I6SS-R	36"	600
MERCURIO	FPMEX42I6SS-R	42"	600

**FEATURES**

- Speed Reduction System (SRS)
- ScotchBrite stainless steel AISI 304
- 4-speed electronic controls
- Auto delay shut-off function
- Clean filter reminder
- LED lighting: 4 X 1,2W
- Metallic filters, removable and washable
- Optional square charcoal filters, Type 3 (FFCHASQC0BL)
- Optional island duct extension, H=120cm (KACL.557#3)



**MIRA**

MODEL	CODE	WIDTH	CFM
MIRA	FDMIR15I5SS-R	16"	500

**FEATURES**

- Speed Reduction System (SRS)
- ScotchBrite stainless steel AISI 304
- Perimeter Suction
- 4-speed electronic controls
- Auto delay shut-off function
- Clean filter reminder
- LED lighting: 4 X 1,2W
- Metallic filters, removable and washable
- Optional round charcoal filter, Type 6 (FFCHAR3COBL)



**PLANE NRSTM**

MODEL	CODE	WIDTH	CFM
PLANE NRSTM	FNPLS36I5SS-R	36"	500
PLANE NRSTM	FNPLS48I5SS-R	48"	500

**FEATURES**

- Speed Reduction System (SRS)
- ScotchBrite stainless steel AISI 304
- NRSTM technology for quieter kitchen
- 4-speed electronic controls
- Auto delay shut-off function
- Clean filter reminder
- LED lighting: 4 X 1,2W
- AirFalmec filter for balanced suction
- Optional Carbon.Zeo filter kit (KACL.961)
- Optional duct extension, H=120cm (KACL.572#1)

Specifications and features may vary. Please refer to the manufacturer's website for the latest updates.

**ISLAND HOODS**



**PLANE TOP**

MODEL	CODE	WIDTH	CFM
PLANE TOP	FFPLN36I5FS-R	36"	500

**FEATURES**

- Speed Reduction System (SRS)
- ScotchBrite Fasteel no finger print
- Perimeter Suction
- 4-speed electronic controls
- Auto delay shut-off function
- Clean filter reminder
- LED lighting: 4 X 1,2W
- Metallic filters, removable and washable
- Optional square charcoal filter, Type 3 (FFCHASQC0BL)
- Optional Carbon.Zeo filter kit (KACL.948#IF)
- Optional duct extension, H=120cm (KACL.557#X)



**POLAR**

MODEL	CODE	WIDTH	CFM
POLAR (Stainless)	FDPLR15I5SS-R	15"	500
POLAR (Matte Black)	FDPLR15I5MB-R	15"	500
POLAR (Matte White)	FDPLR15I5MW-R	15"	500

**FEATURES**

- Speed Reduction System (SRS)
- Optional glass canopy (FDPGL36I0TG)
- ScotchBrite stainless steel AISI 304
- 4-speed electronic controls
- Auto delay shut-off function
- Clean filter reminder
- LED lighting: 3 X 1,2W
- Top filter, removable and washable
- Optional round charcoal filter, Type 6 (FFCHAR3COBL)



**PYRAMID PRO**

MODEL	CODE	WIDTH	CFM
PYRAMID PRO	FPDPR36I9SS-3	36"	1000

**FEATURES**

- ScotchBrite stainless steel AISI 304
- Knob controls
- LED lighting
- Professional baffle filters
- Removable liquid collector

Specifications and features may vary. Please refer to the manufacturer's website for the latest updates.

## ISLAND HOODS



**NEW! SPAZIO**

MODEL	CODE	WIDTH	CFM
SPAZIO (black)	FCSPA70I4MB	70"	360
SPAZIO (stainless)	FCSPA70I4SS	70"	360

### FEATURES

- Circle.Tech technology with Carbon.Zeo filters
- Stainless or black-painted steel chassis
- 4-speed electronic controls
- LED strip lighting (3000K)
- Includes smoked glass shelves
- Equipped with power outlets and USB ports
- Auto delay shut-off function
- Remote control included
- Metallic grease filter, removable and washable
- Available only in filtering version
- Optional accessories:
  - Herbs holder, stainless steel, 2 trays (KACL.744#IF)
  - Paper towel holder, black (KACL.746#HF)
  - Paper towel holder, stainless steel (KACL.746#IF)
  - Support rods, black, H=945mm (KACL.748#HF)
  - Support rods, stainless steel, H=945mm (KACL.748#IF)

## DOWN DRAFTS



**DOWN DRAFT**

MODEL	CODE	WIDTH	CFM
DOWNDRAFT (black)	FDDOW36T6SGB	36"	600*
DOWNDRAFT (stainless)	FDDOW36T6SS	36"	600*

### FEATURES

- Scotch brite stainless steel AISI 304 + Tempered glass (black or stainless steel panel)
- Perimeter suction
- 4-speed touch controls + 24 h function
- Auto delay shut-off function
- Clean filter reminder
- LED strip lighting (4000K)
- Top filter, removable and washable
- Optional remote control (105080053)
- Optional underbase Carbon.Zeo filter kit (KACL.930)
- Optional Carbon.Zeo filter replacement (KACL.931)

**\*The compatible blower, model FDNVUMTR600, is not included with the hood and therefore sold separately.**

Specifications and features may vary. Please refer to the manufacturer's website for the latest updates.

**BUILT-IN HOODS**



**DANILO**

MODEL	CODE	WIDTH	CFM
DANILO	FIDAN28B6SS-3	28"	600
DANILO	FIDAN28B9SS-3	28"	1000

**FEATURES**

- ScotchBrite stainless steel AISI 304
- 4-speed knob controls
- LED lighting: 2 X 1,2W (3200K)
- Labyrinth filters, removable and washable
- Optional round charcoal filter, Type 6 (FFCHAR3COBL)



**GRUPPO INCASSO NRS™**

MODEL	CODE	WIDTH	CFM
INCASSO NRS™	FNINS20B5SS-R	20"	500
INCASSO NRS™	FNINS28B5SS-R	28"	500

**FEATURES**

- Speed Reduction System (SRS)
- Scotch brite stainless steel AISI 304
- NRS™ technology for a quieter kitchen
- 4-speed electronic controls
- Auto delay shut-off function
- Remote control included
- Dynamic LED lighting
- Metallic grease filter, removable and washable
- Optional Carbon.Zeo filter kit (KACL.961)
- Replacement remote control (105080053)



**MARA**

MODEL	CODE	WIDTH	CFM
MARA	FIMAR22B6SS	22"	600
MARA	FIMAR28B6SS	28"	600

**FEATURES**

- ScotchBrite stainless steel AISI 304
- 3-speed slider controls
- LED lighting: 2 X 1,2W (3200K)
- Top filter, removable and washable
- Optional round charcoal filter, Type 6 (FFCHAR3COBL)

Specifications and features may vary. Please refer to the manufacturer's website for the latest updates.

**BUILT-IN HOODS**



**MASSIMO PRO**

MODEL	CODE	WIDTH	CFM
MASSIMO PRO	FIMAS34B6SS-3	34"	600
MASSIMO PRO	FIMAS34B9SS-3	34"	1000
MASSIMO PRO	FIMAS46B9SS-3	46"	1000
MASSIMO PRO 22"D	FIMAX34B6SS-3	34"	600
MASSIMO PRO 22"D	FIMAX34B9SS-3	34"	1000
MASSIMO PRO 22"D	FIMAX46B9SS-3	46"	1000

**FEATURES**

- ScotchBrite stainless steel AISI 304
- Knob controls
- LED lighting: 2 X 1,2W (600 CFM) / 4 x 1,2W (1000 CFM)
- Professional baffle filters
- Optional round charcoal filter, Type 6 (FFCHAR3C0BL). Order qty 2 for 2-motor units.

**Transition required to go from 2x6" round duct to 1x8" round duct is included with all dual motor units.**



**MASSIMO PRO NRS™**

MODEL	CODE	WIDTH	CFM
MASSIMO PRO NRS™	FNMAS30W6SS	30"	600
MASSIMO PRO NRS™	FNMAS36W6SS	36"	600

**FEATURES**

- ScotchBrite stainless steel AISI 304
- NRS™ technology for a quieter kitchen
- 4-speed touch controls + 24h function
- Auto delay shut-off function
- Clean filter reminder
- LED lighting: 2 X 1,2W (30") / 4 x 1,2W (36")
- Professional baffle filters
- Optional Carbon.Zeo filter kit (KACL.961)
- Optional remote control (105080053)



**MERCURIO BUILT-IN**

MODEL	CODE	WIDTH	CFM
MERCURIO BUILT-IN	FPMEU24B3SS	24"	280
MERCURIO BUILT-IN	FPMEU30B3SS	30"	280
MERCURIO BUILT-IN	FPMEU36B3SS	36"	280

**FEATURES**

- ScotchBrite stainless steel AISI 304
- 3-speed mechanical push button controls
- LED lighting: 2 X 1,2W
- Metallic filters, removable and washable
- Optional square charcoal filter, Type 3 (FFCHASQC0BL)

Specifications and features may vary. Please refer to the manufacturer's website for the latest updates.

**BUILT-IN HOODS**



**MOVE**

MODEL	CODE	WIDTH	CFM
MOVE	FDMOV30W5SB	30"	500
MOVE	FDMOV36W5SB	36"	500

**FEATURES**

- Scotch brite stainless steel AISI 304 + black tempered glass
- Pull out panel with controls
- 4-speed electronic controls
- Auto delay shut-off function
- Clean filter reminder
- Metallic grease filter, removable and washable
- Possible to duct wall mounted from rear
- Dynamic LED Lighting (2700K - 5600K)
- Optional telescopic duct cover, H=7.25" (KCVJN.00#3)
- Optional duct cover, H=4.75" (KCVJN.01#3)
- Optional glass shelf, 36" (KACL.107)
- Optional Carbon.Zeo filter kit (KACL.961)



**SABINA**

MODEL	CODE	WIDTH	CFM
SABINA	FISAB22B3SS-1	22"	280
SABINA	FISAB28B3SS-1	28"	280

**FEATURES**

- ScotchBrite stainless steel AISI 304
- 3-speed slider controls
- LED lighting: 2 X 1,2W
- Metallic filters, removable and washable
- Optional round charcoal filter, Type 2 (FFCHAR2COBL)



**VALENTINA**

MODEL	CODE	WIDTH	CFM
VALENTINA	FIVAL28B5SS-R	28"	500
VALENTINA	FIVAL34B5SS-R	34"	500
VALENTINA (black)	FIBUR28B5BK-R	28"	500
VALENTINA (white)	FIBUR28B5WH-R	28"	500

**FEATURES**

- Speed Reduction System (SRS)
- ScotchBrite stainless steel AISI 304 / Tempered glass panel (for black & white)
- Perimeter suction
- 4-speed electronic controls
- Flush finish
- Quick fit installation
- Auto delay shut-off function
- LED lighting: 2 X 1,2W (28") / 4 X 1,2W (34")
- Metallic filters, removable and washable
- Optional round charcoal filter, Type 6 (FFCHAR3COBL)
- Optional remote control (105080053)

Specifications and features may vary. Please refer to the manufacturer's website for the latest updates.

**BUILT-IN HOODS**



**VIRGOLA**

MODEL	CODE	WIDTH	CFM
VIRGOLA	FDVRG24W5SS-R	24"	500
VIRGOLA	FDVRG36W5SS-R	36"	500

**FEATURES**

- Speed Reduction System (SRS)
- Scotch brite stainless steel AISI 304 + tempered turning glass with sloping front panel
- 3-speed electronic controls
- Auto delay shut-off function
- Clean filter reminder
- Dynamic LED lighting (2700K-5600K)
- Metallic filters, removable and washable
- Optional Carbon.Zeo filter kit (KACL.961)
- Possible to duct wall mounted from rear
- Optional telescopic duct cover, H=7.25" (KCVJN.00#3)
- Optional duct cover, H=4.75" (KCVJN.01#3)



**VITTORIO PRO**

MODEL	CODE	WIDTH	CFM
VITTORIO PRO	FIVIT34B6SS	34"	600

**FEATURES**

- Speed Reduction System (SRS)
- ScotchBrite stainless steel AISI 304
- Electronic controls
- Flush finish
- Quick fit installation
- Dynamic LED strip lighting (2700K-5600K)
- Professional baffle filters
- Removable liquid collector
- Remote control included
- Optional round charcoal filter, Type 6 (FFCHAR3COBL)



ITEM	CODE
MAGIC WIPES	KACL.815

- Master Pack of Magic Wipes for stainless steel - 10 individual packages

Specifications and features may vary. Please refer to the manufacturer's website for the latest updates.



## OUTDOOR HOODS



**LINE OUTDOOR**

MODEL	CODE	WIDTH	CFM
LINE OUTDOOR	FOLIN36W120S	36"	1200
LINE OUTDOOR	FOLIN42W120S	42"	1200
LINE OUTDOOR	FOLIN48W120S	48"	1200

### FEATURES

- Scotch brite stainless steel AISI 304
- Professional knob controls
- LED Strip lighting (3000 K)
- Professional baffle filters
- Removable liquid collector
- Optional duct cover extension, 30"+30"H (KCPHN.007#IF)



**PYRAMID OUTDOOR**

MODEL	CODE	WIDTH	CFM
PYRAMID OUTDOOR	FOPYR36W120S	36"	1200
PYRAMID OUTDOOR	FOPYR42W120S	42"	1200
PYRAMID OUTDOOR	FOPYR42W120S	48"	1200

### FEATURES

- Scotch brite stainless steel AISI 304
- Professional knob controls
- LED Strip lighting (3000 K)
- Professional baffle filters
- Removable liquid collector
- Optional duct cover extension, 30"+30"H (KCPHN.007#IF)



**ZEUS OUTDOOR**

MODEL	CODE	WIDTH	CFM
ZEUS OUTDOOR	FOZEU36W120S	36"	1200
ZEUS OUTDOOR	FOZEU42W120S	42"	1200
ZEUS OUTDOOR	FOZEU48W120S	48"	1200

### FEATURES

- Scotch brite stainless steel AISI 304
- Professional knob controls
- LED Strip lighting (3000 K)
- Professional baffle filters
- Removable liquid collector
- Optional duct cover extensions:
  - KCPHN.001#IF - 36"W Duct Cover extension
  - KCPHN.002#IF - 42"W Duct Cover extension
  - KCPHN.003#IF - 48"W Duct Cover extension
  - KCPHN.007#IF - 20"W x 60"H Duct Cover extension

Specifications and features may vary. Please refer to the manufacturer's website for the latest updates.

## FILTRATION

### Anti-grease Filters.

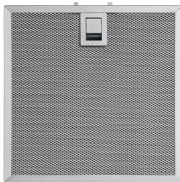

#### **Metallic Filters.**

These filters have an internal multi-layer aluminum structure of corrugated mesh to maximize the filtering surface.

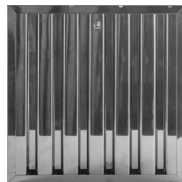

#### **Professional Baffle Filters.**

Professional baffle filters come standard in all hoods in the Professional Collection. Their criss-cross structure effectively collects oils and vapors that can easily be removed and cleaned.

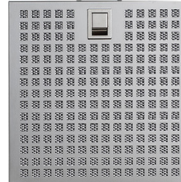

#### **Top Filters.**

Top grease filters maintain the high retention performance of the metal filters with the addition of a "chessboard" external frame in Scotch Brite steel with a smooth surface that facilitates cleaning and at the same time qualifies the aesthetic appearance..

### Anti-odor filters.



#### **Active Charcoal Filters.**

Charcoal filters contain active carbons that absorb odors created by cooking. As the filters become less efficient with time, it is recommended to be replaced at least every 4 months.

**Type 3 (rectangular)**  
code FFCHASQC0BL

**Type 2 (round)**  
code FFCHAR2C0BL (pair)

**Type 6 (round)**  
code FFCHAR3C0BL (pair)

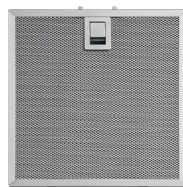

#### **Combined High Performance Filters (Silence - NRS™ Collection).**

Wash in dishwasher with your usual detergent at a temperature not exceeding 149°F, if possible with no other contents. After washing, regenerate the filter in the oven at 176°F for 20 minutes.

**Verso NRS™**  
code KACL.959

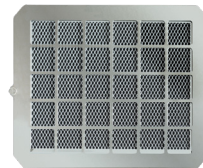

#### **Carbon.Zeo Filters.**

The Carbon.Zeo combined filter has a guaranteed minimum life of 3 years, but is expected to last 5 years under conditions of normal use. We recommend that it be regenerated every 18 months by placing it in an oven at 392°F for two hours.

**Lumina NRS™**  
**Gruppo Incasso NRS™**  
**Plane NRS™**  
**Line Pro NRS™**  
**Massimo Pro NRS™**  
**Move**  
code KACL.961

Specifications and features may vary. Please refer to the manufacturer's website for the latest updates.

FILTERING INNOVATION

Accessories for better filtration.

**Carbon.Zeo**  
**technology.**

Carbon.Zeo filters use natural materials such as active carbon and zeolite, a mineral of volcanic origin with a microporous crystalline molecular structure that absorbs fumes and unpleasant odors.

On contact with the flow of vapors, zeolite releases heat, helping to reduce moisture caused by cooking.

The Carbon.Zeo combined filter has a guaranteed minimum life of 3 years, but is expected to last 5 years under conditions of normal use. The filter should be regenerated every 18 months by placing it in an oven at 392°F for two hours.



**Ceiling.**

**Ceiling filter unit kit.**

This kit enables Falmec ceiling hoods to be installed in recirculation mode. This is installed flush-mounted on the same false ceiling area as the hood. And thanks to the white painted steel frame and white satin glass inner panel, it integrates harmoniously with the kitchen environment.

This solution combines aesthetic elegance with outstanding filter performance with a Carbon.Zeo filter.

**Carbon.Zeo**

**Filter unit**  
**KACL.939#BF**  
**Spare part**  
**KACL.928**

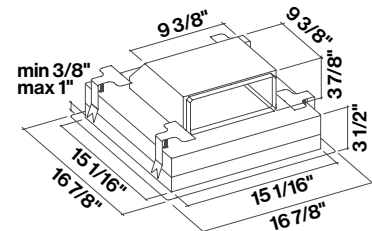

**Cut-out size**  
**15 9/16" x 15 9/16"**

Specifications and features may vary. Please refer to the manufacturer's website for the latest updates.

**Wall.**



**Filter unit for sloped hoods.**

This kit is designed to enhance performance of sloped hoods in recirculation mode.

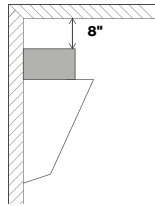

**Carbon.Zeo**

This accessory can also be used with previously installed hoods to enhance performance. The unit is created in stainless steel AISI 304 for long-lasting use and to facilitate cleaning.

**Filter unit**  
**KACL.941**  
**Filter replacement**  
**KACL.943**

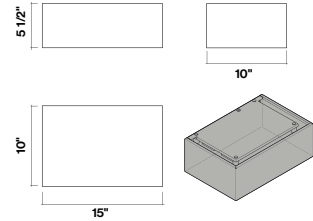

**Filter unit for t-shaped wall hoods.**

This kit is designed to enhance extraction and recirculation for all Falmec wall hoods.

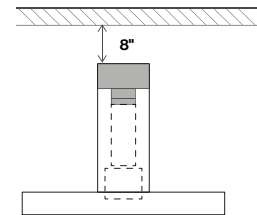

**Carbon.Zeo**

**Filter unit**  
**KACL.948#IF**

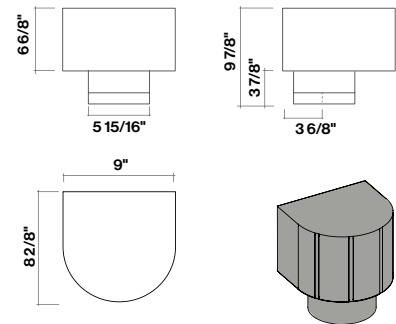

**Island.**



**Filter unit for island hoods.**

This kit is designed to enhance extraction and recirculation for all Falmec island hoods.

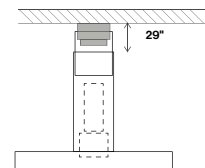

**Carbon.Zeo**

**Filter unit**  
**KACL.949#IF**  
**Filter replacement**  
**KACL.934**

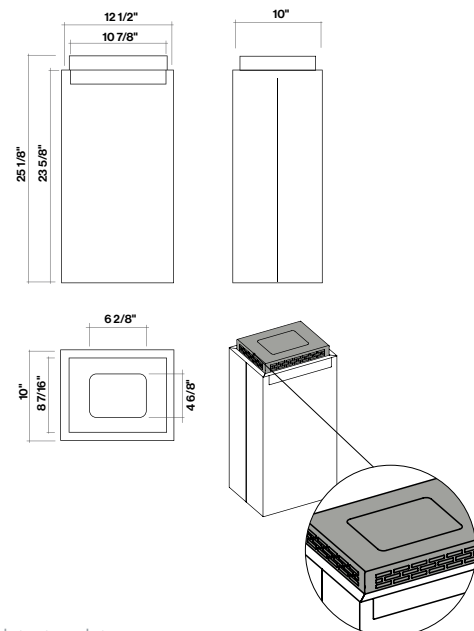

Specifications and features may vary. Please refer to the manufacturer's website for the latest updates.

**Built-in/Wall.**



**Filter unit for Built-in hoods.**

This kit is designed to enhance extraction and recirculation for all Falmec built-in hoods.

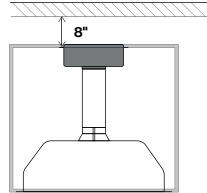

**Carbon.Zeo**

**Filter unit**  
**KACL.950**  
**Filter replacement**  
**KACL.934**

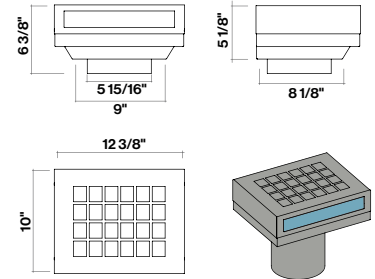

**Downdraft.**



**Downdraft filter unit.**

This kit is equipped with Carbon.Zeo technology and are installed under the kitchen plinth.

**Carbon.Zeo**

**Under base filter unit**  
**KACL.930**  
**Filter replacement**  
**KACL.931**

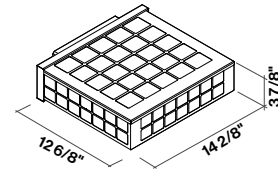

Specifications and features may vary. Please refer to the manufacturer's website for the latest updates.

## FILTER CHARTS

Hood	Carbon filter	Carbon.Zeo filtering kit	Carbon.Zeo filtering kit Spare part
Afrodite	FFCHAR3C0BL	-	-
Built-in Mercurio	FFCHASQC0BL	-	-
Danilo	FFCHAR3C0BL	-	-
Down Draft	-	KACL.930	KACL.931
Eros	FFCHAR3C0BL	-	-
Gruppo Incasso Burano	FFCHAR3C0BL	KACL.950	KACL.934
Gruppo Incasso NRS™	-	KACL.961	KACL.961
Line Pro NRS™	-	KACL.961	KACL.961
Line Outdoor	-	-	-
Lumen Island	FFCHASQC0BL	KACL.949#IF	-
Lumen Wall	FFCHASQC0BL	KACL.948#IF	-
Lumen Island 175	FFCHASQC0BL	KACL.949#IF	-
Lumina NRS™	-	KACL.961	KACL.961
Mara	FFCHAR3C0BL	-	-
Massimo Pro	FFCHAR3C0BL	-	-
Massimo Pro XL	2 x FFCHAR3C0BL	-	-
Massimo Pro NRS™	-	KACL.961	KACL.961
Mercurio	FFCHASQC0BL	-	-
Mira Wall	FFCHASQC0BL	-	-
Mira Island	FFCHAR3C0BL	-	-
Move	-	KACL.961	KACL.961
Plane Top	FFCHASQC0BL	KACL.948#IF	-
Plane Black	FFCHASQC0BL	KACL.948#IF	-
Plane NRS™	-	KACL.961	KACL.961
Polar	FFCHAR3C0BL	-	-
Polar Black/White	2 x FFCHAR3C0BL	-	-
Prisma	FFCHAR3C0BL	KACL.941	-
Pyramid Outdoor	-	-	-
Pyramid Pro	-	-	-
Pyramid Pro NRS™	KACL.948#IF	-	-
Sabina	FFCHAR2C0BL	-	-
Valentina	FFCHAR3C0BL	-	-
Verso NRS™	KACL.959	-	-
Virgola	FFCHASQC0BL	KACL.950	KACL.934
Vittorio Pro	FFCHAR3C0BL	-	-
Vulcano	FFCHASQC0BL	-	-
Zeus Pro	-	-	-
Zeus Pro NRS™	KACL.948#IF	-	-
Zeus Outdoor	-	-	-

Specifications and features may vary. Please refer to the manufacturer's website for the latest updates.

## WARRANTY

### GENERAL TERMS OF SALE AND GUARANTEE

Guarantee: Falmecc Spa guarantees its products for a period of 12 months starting from the date of delivery, exception made for the products for which different conditions are agreed upon on order. The guarantee doesn't cover the damages caused by wrong or incorrect maintenance, by improper use of the products, by fault or malice or by force majeure. The wooden components or details of any product indicated in the price list, in particular as regards vein, cut, porosity, polishing, are not covered by the guarantee either. The products which were not assembled by Falmecc Spa are not guaranteed.

Specifications and features may vary. Please refer to the manufacturer's website for the latest updates.

## PRODUCT GUIDE **2023**

**falmec**  
Life inspired.

T 800 361 0799 F 450 682 7943

[www.distinctive-online.com](http://www.distinctive-online.com) [info@distinctive-online.com](mailto:info@distinctive-online.com)

### HEAD OFFICE / WAREHOUSE / SHOWROOM

2025 Cunard, Laval (QC) H7S 2N1

### PARTS & SERVICE

[service@distinctive-online.com](mailto:service@distinctive-online.com)

800-561-7265

### ORDER DESK

[orderdesk@distinctive-online.com](mailto:orderdesk@distinctive-online.com)